

Features & Benefits

Scalability

The Vertex Channel Emulator is scalable to a broad range of applications. The hardware is capable of supporting as few as two bidirectional RF channels for basic RF testing, and up to as many as 32 unidirectional RF channels to support high channel density such as MIMO OTA, all in one single, small form instrument.

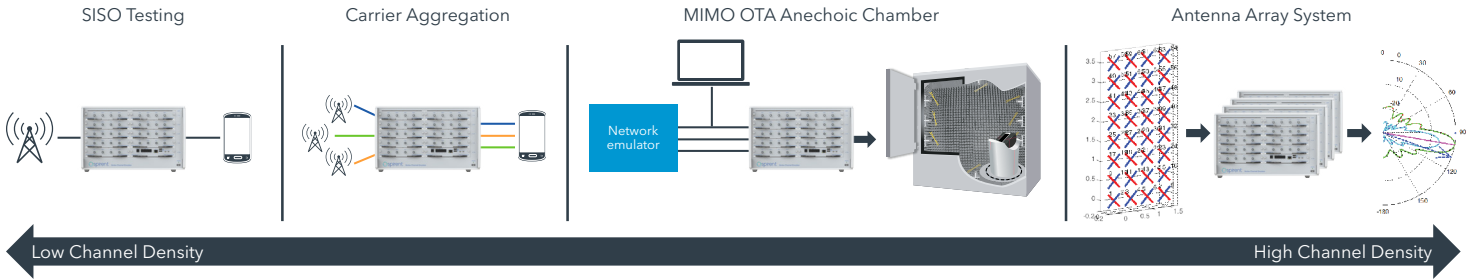

Modularity

Separate RF modules are optimized for unidirectional or bi-directional applications and support a variety of different frequency bands. This allows the Vertex Channel Emulator to be configured for specific test needs using minimal hardware. Field-replaceable RF and DSP modules facilitate upgrades and enhance serviceability. Each RF module has an independent Local Oscillator (LO), allowing the Vertex Channel Emulator to support multiple carrier frequencies in the same instrument.

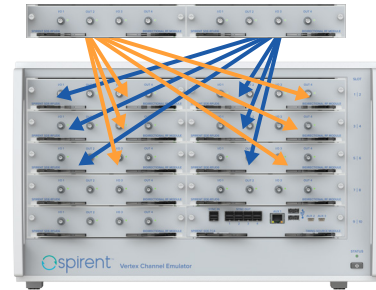

High Channel Density in a Compact Space

The Vertex Channel Emulator system supports up to 36 RF ports and 256 digital links in one 6U rack height. It enables more efficient use of hardware for tests that require higher RF channel counts.

Remote Programming Interface (RPI)

Remote programming is supported through TCP/IP with both telnet or SSH protocol. The RPI commands provide seamless backward compatibility to the Spirent VR5 HD channel emulator.

Comprehensive Channel Modeling Support

The built-in Vertex propagation library offers a vast selection of standard channel models, while making it easy to edit and save changes to both the standard as well as user-defined models. Classical and 2D/3D geometrical channel models are supported and the independent channel modeling feature allows one Vertex to support up to 16 nodes for mesh network applications.

Live Streaming Dynamic Environment Emulation (LSDEE)

Live Streaming Dynamic Environment Emulation is an advanced feature addition to the Vertex Channel Emulator RPI. It provides a very high-speed control mechanism for an extensive set of emulation parameters.

Ease of Use

Complicated test setups are made simpler with an easy-to-use Graphical User Interface (GUI). Intuitively-designed libraries of connection setups make it easy to navigate through complicated configurations by presenting information in a clear way. For debugging purposes, important information is displayed in real time, including power level tracking of each RF port.

Unlike traditional DEE, which allows a user to create predefined scenarios for modifying channel parameters during a test run, there is no requirement to predefine or pre-compile channel emulation states or inter-state durations. LSDEE reduces processing time and monitors device behavior to make real-time scenario adjustments. This is extremely beneficial for high-speed scenarios where manual intervention can interfere with time-sensitive environmental changes. The same set of emulation parameters can be supported as with traditional DEE.

Key Test Applications

MIMO OTA

MIMO OTA applications require high channel density, based on the number of probes used in the test setup. The Vertex Channel Emulator can be used in both anechoic and reverberation chamber test setups and can switch between chamber types in minimal time. For anechoic chambers, Vertex supports up to 32 RF probes and two carriers with 16 dual polarized probes or 8 dual polarized probes on one instrument. For reverberation chambers, up to four carriers can be aggregated on one instrument.

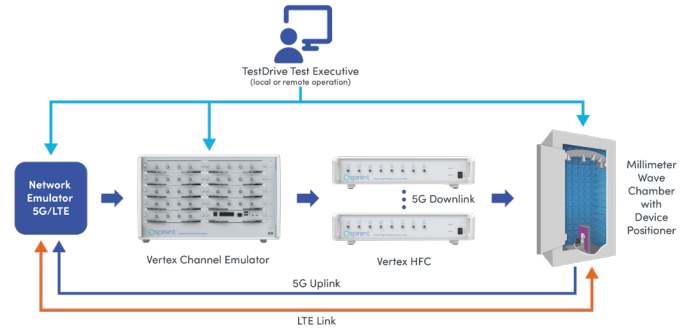

Virtual Drive Testing

Supporting up to sixteen SISO cells or eight 2x2 MIMO cells on one instrument, Vertex accurately reproduces real network propagation conditions in the lab.

The ability to emulate a high number of cells, combined with Spirent's Live2Lab® Virtual Drive Test-Conversion Tool (Live2Lab VDT-CT) software, makes the laborious process of drive testing easy and repeatable. Live2Lab VDT-CT can convert a large variety of log file types (QXDM, JDSU, Accuver, Transcom, Anite Nemo, etc.) into reproducible drive route simulations in a lab environment. Additionally, Vertex allows easy debugging of power level issues by allowing users to dynamically monitor the power level on each port.

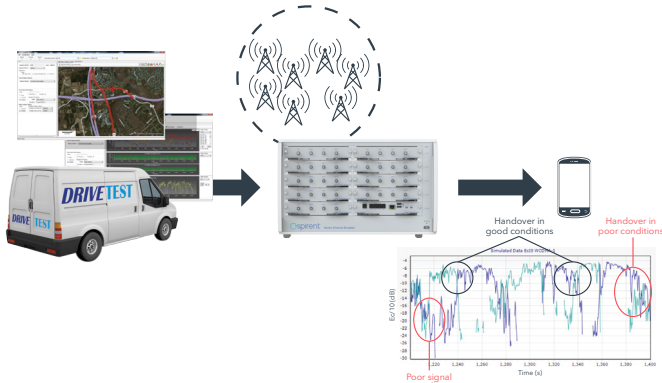

AAS, Massive MIMO and MIMO Beamforming

Up to 8 Vertex instruments can be integrated into one system with the Vertex Baseband Synchronizer (VBS). With the VBS, the Vertex units in a system can work standalone or all together as a complete solution for massive MIMO applications with real-time or IQ playback fading.

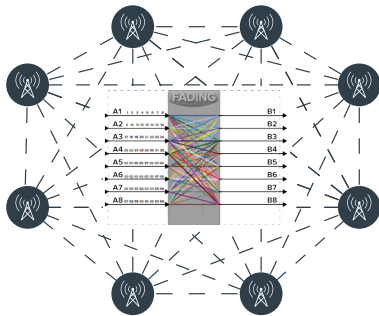
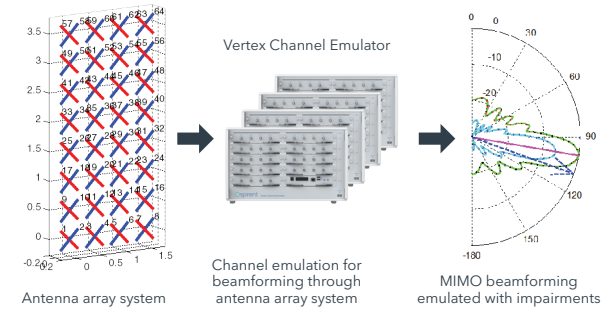

Carrier Aggregation

Supporting up to four 2x2 bi-directional carriers on one instrument, Vertex can be used for carrier aggregation scenarios. Each radio link can be independently modelled, simulating channel conditions to represent multiple carriers on the same eNodeB or from different eNodeB's. The same setup can also be used for simulating channel conditions that trigger handovers and on Coordinated Multipoint (CoMP) applications as well.

Mesh Networks

Mesh network applications require each node to independently communicate with each other. From a channel emulation perspective, this implies that each radio link needs to be emulated with a different fading profile simultaneously, placing heavy demand on the number of RF antenna ports required in addition to the processor load. Vertex supports up to 16x16 independent channel models on a single instrument, providing the capability to test up to a sixteen node mesh network.

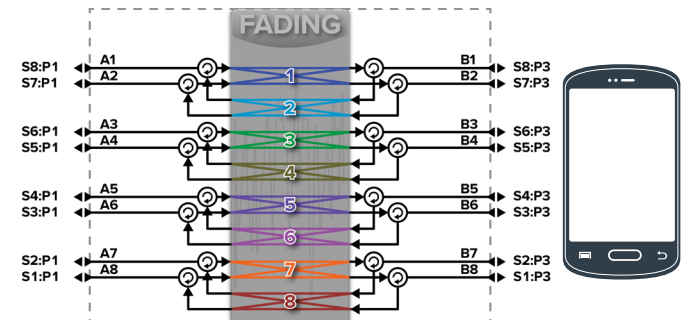

Graphical User Interface

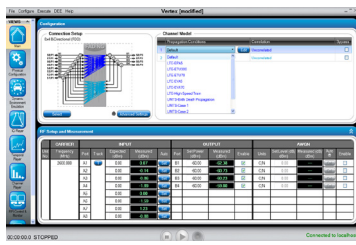

For users familiar with Spirent’s VR5 HD Channel Emulator, the Vertex Channel Emulator presents a seamless transition, as it has been developed with the same GUI features. The Vertex GUI is very easy to use and presents clear and concise information even for the first-time user. The GUI can be accessed using a cable hooked up to the Vertex display port or through the controller laptop. Connection setup and RF parameters for channel modeling can be easily configured to run in real-time mode. A comprehensive set of ready-to-run standard models is provided, making it easy to select and play. Setup of most test cases is a matter of using a few mouse clicks and drop down menus.

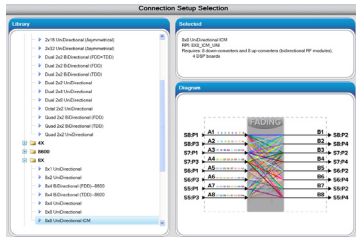

The GUI provides an easy-to-read display for high channel density features that can be complicated to set up. For example, the connection setup for an 8x8 MIMO application, or 64 radio links, can be easily viewed using the pre-loaded option from the Connection Setup library.

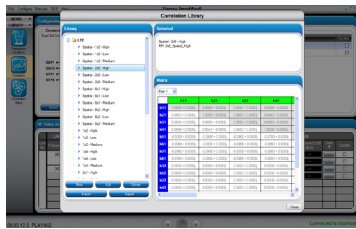

Configuring the MIMO correlation matrix is easy and convenient to do on the Vertex GUI. Complicated matrices such as a 2x8 configurations can be created using spreadsheet-type entries, rather than spending the time writing elaborate test scripts for creating the correlation matrices.

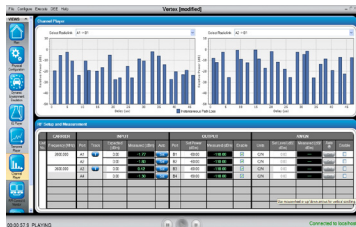

The Vertex GUI displays real-time information regarding channel power with respect to fading. This instantaneous display enables quick detection of deviations from expected behavior and the ability to efficiently debug problems.



The cable connection diagram built-in to the Vertex GUI presents the actual cabling connections that need to be made. This feature makes it easy to cable complicated connection setups and minimizes cabling error. The image shown is the cabling setup for an 8x8 unidirectional configuration.

Additionally, the built-in temporal player feature facilitates real-time tracking of power levels at each port. This is especially useful for handover scenarios, which are based on power levels between the serving cells.

Technical Specifications

RF configuration	<ul style="list-style-type: none"> • With bidirectional module: from SISO up to 8x8 MIMO with bidirectional fading • With unidirectional module: up to 2x32 and dual 2x16 • Multiple instruments: Two instruments can be fully integrated into a system; additional instruments can be synchronized for more complex connection setups.
RF inputs	Up to 18
RF outputs	Up to 32
Digital channels	Up to 256 (40MHz or 100MHz bandwidth); up to 64 (200MHz bandwidth) with a single Vertex instrument
Bandwidth	40MHz, 100MHz, 200MHz, 400MHz, 600MHz, 800MHz, 1000MHz, 1200MHz
Frequency range	30MHz to 5925MHz
RF input	Input level range: -50 to +15dBm Level resolution: 0.1dB Damage level: +33dBm (Peak)
RF output level	Min/max range: -110 to -10dBm (RMS) Resolution: 0.1dB
Input and output power meters	Modes: <ul style="list-style-type: none"> • Continuous • RF burst-triggering for gated input signals
Residual EVM	-40dB typical
Residual noise	Better than -165dBm/Hz at a set output level of -45dBm
RF port VSWR	1.5:1
Independent paths	Up to 24 paths per digital channel
Delay	0 to 1s at bandwidths ≥ 100 MHz; 0 to 2s at bandwidths $= 40$ MHz; 0.1ns resolution
Relative path loss	0 to 40dB
Dynamic channel parameters	<ul style="list-style-type: none"> • Sliding delay (moving propagation) • Birth-death delay • 3GPP High-Speed Train (HST) profiles log normal (shadow fading)

Technical Specifications (cont'd)

Dynamic Environment Emulation (DEE) and Live Streaming DEE (LSDEE)	<p>Controllable parameters:</p> <p>State duration, channel output level, AWGN on/off, C/N, path on/off, relative power and delay, LOS AoA, K factor, frequency shift, Doppler velocity, MIMO branch phase, power imbalance, and correlation, link phase and loss, bulk delay, path phase, geometrical characters, port Doppler</p> <p>Channel model update rate: 100 times per second</p> <p>Start method: Triggered, free play</p> <p>Play method: Run for N loops, wrap around</p> <p>Smoothing supported</p>
Standards-based models	LTE, Wi-Fi (802.11a/b/g, 802.11n, 802.11 ac, 802.11 ax), IMT-A, WiMAX, UMTS, CDMA2000®, HSPA, GSM, SCM/SCME (ITU-R M.2135), WINNER, Butler, 5G TDL and CDL, D2D
Custom models	Easy-to-use interface allows the user to create custom channel models or edit any of the standard channel models in the library
Fading mode	Classical, GCM, 3D GCM, MIMO OTA
Real-time fading	<p>Types: Rayleigh, Rician, pure Doppler, frequency shift, phase shift, Log normal (Shadow) fading</p> <p>Fading Doppler: Up to 12kHz</p> <p>Doppler frequency shift: -2MHz to 2MHz</p> <p>Repetition interval: >7 days</p> <p>Relative phase: 0-360°, 0.1° resolution</p> <p>Rician K factor: -30 to +30dB</p> <p>Level crossing rate (LCR) accuracy: < ±2.5% deviation from theoretical LCR curve of the simulated vehicle velocity</p> <p>Fading power spectrum: classical 6dB, flat, classical 3dB, rounded, rounded 12dB, bell</p> <p>Correlation: programmable complex correlation between paths</p>
IQ-playback fading	Supports IQ playback fading
AWGN	<p>C/N Ratio: -40 to +40dB</p> <p>Accuracy: ±0.1dB</p> <p>Bandwidth: up to 400MHz</p> <p>Settable modes: C/N, Eb/No, N</p>
Control interface	<p>PC-based graphical user interface</p> <p>Remote programming through ethernet</p>
10MHz internal reference accuracy	1ppm

About Spirent Communications

Spirent Communications (LSE: SPT) is a global leader with deep expertise and decades of experience in testing, assurance, analytics and security, serving developers, service providers, and enterprise networks. We help bring clarity to increasingly complex technological and business challenges. Spirent's customers have made a promise to their customers to deliver superior performance. Spirent assures that those promises are fulfilled. For more information visit: www.spirent.com

Americas 1-800-SPIRENT

+1-800-774-7368 | sales@spirent.com

Europe and the Middle East

+44 (0) 1293 767979 | emeainfo@spirent.com

Asia and the Pacific

+86-10-8518-2539 | salesasia@spirent.com